



Electrical Accessories

WIRING DEVICES & LIGHTING



Nema Configuration		Male Plug	Female Connector	Flush Receptacle	Manufacturer
2 Pole 3 Wire					
5-15	15A 125V	5266MA	5269MA		Marinco
		5266N	5269N		Bryant
L5-20	20A 125V	205P	205C	205R	Marinco

GFCI Protection Adapters

Cat. No.	Length	Gauge	Plug		Connector	
*1442G2	2'	12/3	Straight Blade 15A/125V	NEMA 5-15P	Straight Blade 15A/125V	NEMA 5-15R



Twist Lock Plug & Connector Light Strings

Cat. No.	Length	Gauge	Type	Jacket	Sockets	Guard	Pack	Weight
96122	100	12/3	SJTW	Vinyl	10	*Pre-A Plastic	1	20

50 Amp Wiring Devices

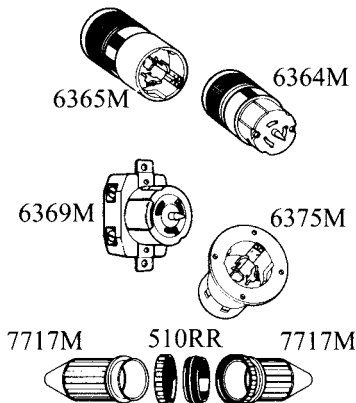

Description	Plug	Connector	Receptacle	Inlet	Manufacturer
50 Amp 125/250 Volt	6365M	6364M	6369M	6375M	Marinco
Rubber Boots	7717M	7715M			Marinco
Sealing Rings	510RR				Marinco
Power Outlet			SR50		



Electrical Accessories

Portable Lighting Systems

UL Listed

Cat. NO. Description

Hand-Held Light System

07775 500 Watt Bulb. Adjustable pivot handle with weatherproof On/Off Power Switch. No tri-pod and telescoping post



Dual Head Light System

07776 Two 500 Watt Pivoting Heads, Separate On/Off Power Switches for Each Fixture. Tri-Pod Included.

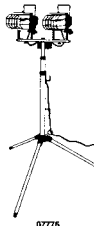

Single Head Light System

07777 500 Watt Bulb. Ideal for Connecting Lights in Series. Tri-Pod Included.

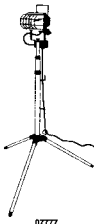

Accessories

07880 Replacement 500 Watt Bulb

Temporary Lighting Cord-O-Lite™

UL Listed/Complies with 1996 National Electric Code/Meet OSHA Specifications. Our most rugged lighting system. Heavy duty 12/3 SJTW-A (yellow) with molded light sockets. Accommodates bulbs up to 150 watts. Available with easy-open plated metal lamp guards, or snap-on plastic guards. Standard 20 amp locking ends.

Locking 20 amp connectors

Cat. No.	Wire Ga/Cond	Wire Type	Length in Ft.
07558	12/3 SJTW	50ft. Metal	
07559	12/3 SJTW	100ft. Metal	
07568	12/3 SJTW	50ft. Plastic	
07569	12/3 SJTW	100ft. Plastic	

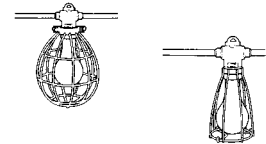

Replacement Guards

07200 Replacement Metal Guard
 07300 Replacement Plastic Guard

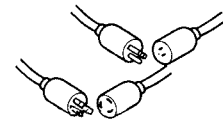

Rough Service Replacement Bulbs

Cat. No.	Volt	Watt	Description
05903	125	100	Rough Service



Temporary Power Cords Extension Cords

Catalog# Description

01918 50 ft. 6/3 & 8/1 Type SEO, 125/250 volt, 50 amp
 01919 100 ft. 6/3 & 8/1 Type SEO, 125/250 volt, 50 amp

Our rugged temporary power cords are designed for use with temporary power distribution centers with input current of 50 amp, 125/250 volt A.C., 3-pole, 4-wire.

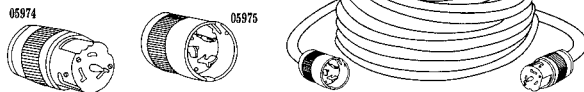

Tri-Source® In-Line Heavy Duty GFCI with Handle 120 Volts/1800 Watts

Cat. No.	Wire Ga/Cond	Wire Type	Length in Ft.
02843	12/3	SJEOW	2.5

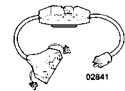

Quad Box - 15 Amp GFCI with Handle 120 Volts/1800 Watts

02816	12/3	SJEOW	6
-------	------	-------	---



GFCI Extension Cord with Molded Tri-Source®

02839	12/3	SJEOW	100
-------	------	-------	-----

Locking Extension Cords

UL Listed - Meet OSHA Specifications

Twist-to-lock extension cords and adapters designed for use in construction and industrial applications where extra protection and durability are needed. All are constructed with heavy-duty 12 gauge wire and molded locking male and female connectors.

600 Volt - Black

09028	12/3	STW	50
09029	12/3	STW	100

Adapters - Yellow

09020	12/3	STW	9 Inches
Converts a standard 15 Amp grounded receptacle to a twist-to-lock 20 Amp receptacle			
09021	12/3	STW	9 Inches
Converts a twist-to-lock 20 Amp receptacle to standard 15 Amp grounded receptacle			



09029

"Y" Adapter

09022	12/3	STW	20 Inches
-------	------	-----	-----------

"W" Adapter

09023	12/3	STW	20 Inches
-------	------	-----	-----------



09020

Polar/Solar Plus™ Extension Cord (SJEOW)

Polar/Solar® Plus Cord, made with Coleman's exclusive T*Prene® insulation, stays flexible even under the most extreme temperatures. Weighs 1/3 less and is 2-1/2 times more abrasion resistant than ordinary cords. Available in 16, 14, 12 and 10 gauge and in 25, 50 and 100 ft. lengths. Meets OSHA hard usage requirements.

Polar/Solar Plus® Extension Cords Featuring a Power Indicator Light

Cat. No.	Wire Ga/Cond	Wire Type	Length in Ft.
01689	12/3	SJEOW	100



Round Orange Vinyl

Cat. No.	Wire Ga/Cond	Wire Type	Length in Ft.
04118	12/3	SJTW	50
04119	12/3	SJTW	100



Three Conductor Round Orange Cord - 300 volt

02407	14/3	SJTW	25
02408	14/3	SJTW	50
02409	14/3	SJTW	100



Electrical Accessories

X-treme Box® is available with the following configurations and approvals:

Part Number	Description	Power Inlet	Power Outlets	Overload, Overvoltage & Open Neutral Protection	Wt.
01950-00-06	Portable Power Distribution Locking	50A 125/250V California style flanged inlet	(1) 50A 125/250V California style receptacle	None	34
			(1) NEMA L6-30R 30A 250V lock receptacle w/cover	circuit breaker protected	
			(6) NEMA L5-20R 20A 125V lock receptacles w/cover	circuit breaker GFCI protected	
01960-00-02	Portable Power Distribution Locking - ETL Listed NEMA 3R enclosure requirement compliant	50A 125/250V California style flanged inlet	(1) 50A 125/250V California style receptacle w/cover	None	34
			(1) NEMA L6-30R 30A 250V lock receptacle w/cover	circuit breaker protected	
			(6) NEMA L5-20R 20A 125V lock receptacles w/cover	circuit breaker GFCI protected	
01970-00-02	Portable Power Distribution Straight Blade - ETL Listed NEMA 3R enclosure requirement compliant	50A 125/250V California style flanged inlet	(1) 50A 125/250V California style receptacle w/cover	None	34
			(1) NEMA L6-30R 30A 250V lock receptacle w/cover	circuit breaker protected	
			(6) NEMA L5-20R 20A 125V lock receptacles w/cover	circuit breaker GFCI protected	

Extension Cords

Part No.	Description
01918	50 ft. 6/3 & 8/1 Type SEOW, 125/250 volt, 50 amp
02918	50 ft. 6/3 & 8/1 Type STW, 125/250 volt, 50 amp
01919	100 ft. 6/3 & 8/1 Type SEOW, 125/250 volt, 50 amp
02919	100 ft. 6/3 & 8/1 Type STW, 125/250 volt, 50 amp

Replacement Ends/Adapter

Part No.	Description
05974	Female, 3-pole, 4-wire, 50 amp 125/250 volt grounding
05975	Male, 3-pole, 4-wire, 50 amp 125/250 volt grounding
01920	50 amp "Y" adapter 6/4 SEOW Black

